

Article number: 0106033

Description: Retaining ring JV 17

## Measures

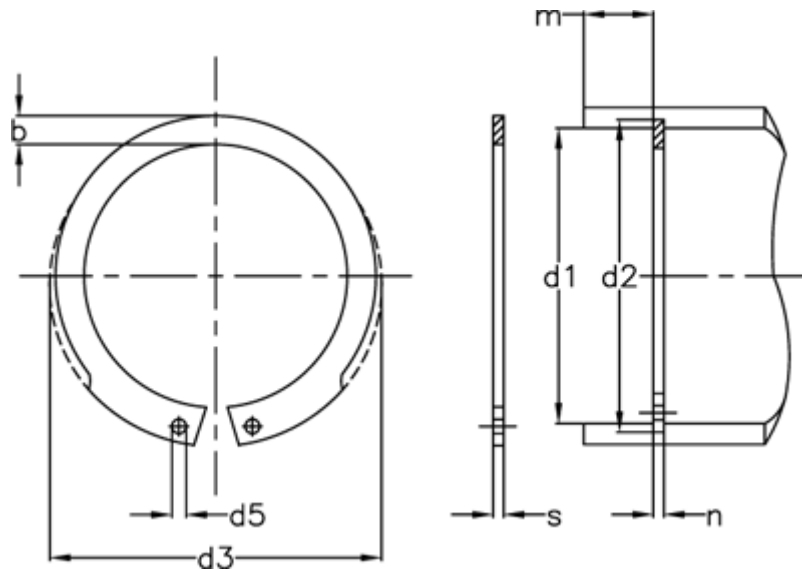

AN mm <sup>2</sup>	= 11	FRg kN	= 3.0	tol	= 0.1
b	= 2.1	FR kN	= 5.8	tol	= -0.06
d1	= 17	g	= 1.0	tol	= +0,42-0,13
d2	= 17.8	K kN-mm	= 21.2	tol	= +0,11
d3	= 18.3	m min	= 1.10	Tong	= ZGJ-1
d5 min	= 1.3	Nominal drive	= 1.5	Weight kg/1000	= 0.58
Description	= JV 17	s	= 1.00		
FN kN	= 1.70	t	= 0.40		